

# LED-Display WA46



## LED-Display WA46



The displays of the WA46 series are characterized by a display area of 46 x46 mm. The design is adapted to the series WT40 push button. A plurality of symbols is available. Multiple displays and audio feedback can be configured. The displays are available with various colors as well as in customized designs.

Technical data	
Mounting plate	80 mm x 80 mm, aluminum RAL 9006
Cover frame	optional, 90 x 90 mm, aluminum RAL 9006
Mounting plate	4 x screw
Mounting hole	diameter 65 mm
Mounting depth	25 mm
Color of piktogram	optional: red, green or yellow
Diameter of piktogram	46 mm x 46 mm
Vanish effect	optinal: 0 - 75%
Power supply	24 VDC $\pm$ 30%, Reverse Polarity Protection
Connection	0,08...1,5 mm <sup>2</sup> , spring cage, WAGO 256
Backgroun light	LED
Operating current	80 -90 mA
Standards	EN 50155, EN 45545
Store temperature	-25...+70°C/ 95% r.h.(T1 class acc. EN 50155), non condensing
Operating temperature	-30...+85°C/ 95% r.h.(T1 class acc. EN 50155), non condensing
Altitude	1.400 m above sea level (A1 acc. EN 50125)
Warrenty	1 year









With 24 VDC input voltage and the standard size of 80 x 80 mm, the WA46 is prepared for common use on rail vehicles

The WA46 meets the requirements of EN 50155 for electronic equipment used on rolling stock.

It can be supplied OEM versions with Labelling as per your choice.

Cover frame (size 90x90mm) for all models as an option.

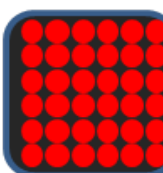
Standard foils with the identification number

	30-105938 (34604)		30-104412 (28817)
	30-105816 (32865)		30-107657 (56724)
	30-100119 (13574)		30-100124 (16721)
	30-100125 (17982)		30-100126 (19007)
	30-100118 (13573)		30-105554 (30821)

Rear view:



m.u.t GmbH  
WCelAzV5  
MBe 05/98

## Diameters:

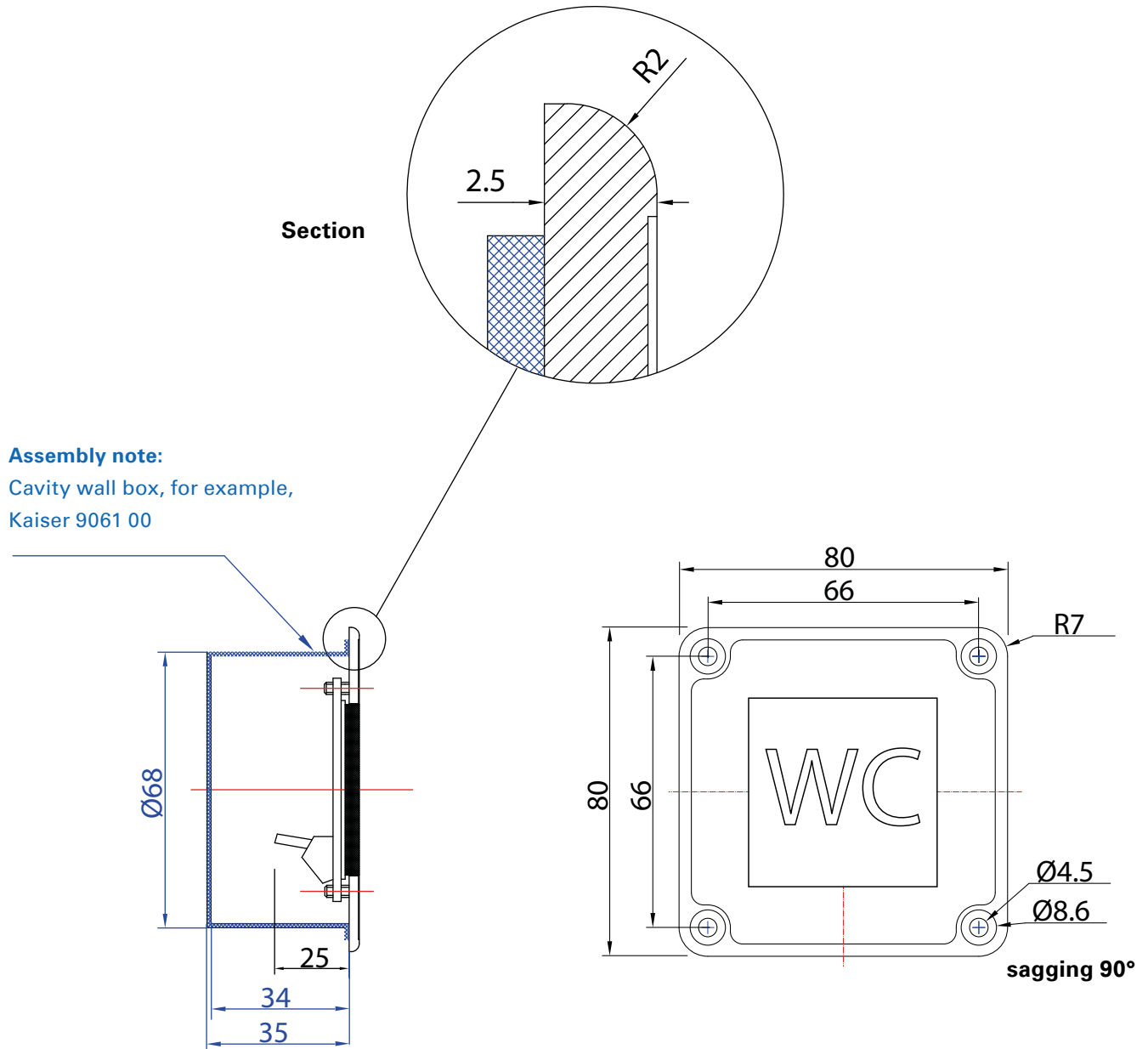

Do you have any questions?

Sascha Otto  
Key Account Manager

+49 (0)4103 9308-120  
+49 (0)173 2362486

sotto@mut-group.com  
www.mut-group.com